

AIO SHOWER SYSTEM

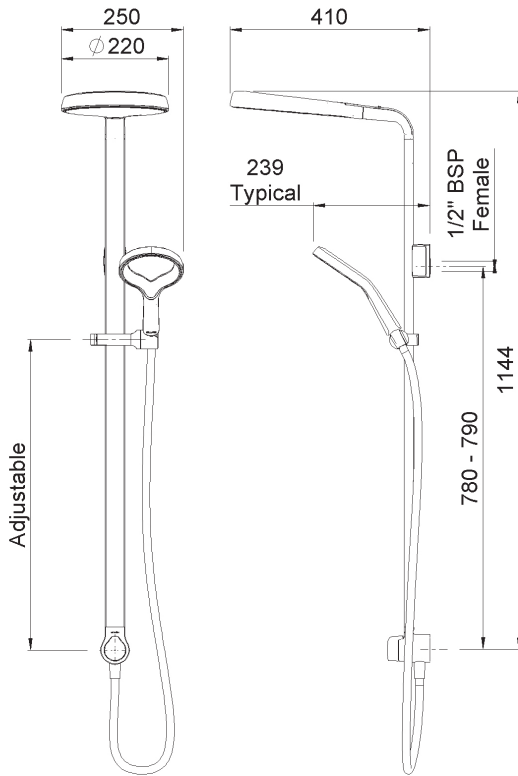

CONSTRUCTION: Brass & ABS
CARTRIDGE/VALVE TYPE: N/A
SUPPLY: Suitable for high pressure only
INLET CONNECTIONS: 1/2" BSP
WORKING PRESSURES: 1.0 - 5.0 bar

- Limescale resistant - hydrophobic properties resists the build up of limescale
- Water efficient without compromising performance
- Integrated diverter
- Rotary ceramic diverter cartridge for smooth operation
- Quick fit connector between head & rail for easy installation
- Comes complete with 15mm (1/2" BSP) threaded connection
- Fitted with 12 l/min flow regulator in overhead and 9 l/min in handset
- Twin with a Kaha or Kiri single outlet shower valve

AOSSCPUK

Open Outlet Flow (Bar - l/min)

BAR	0.3	0.5	1.0	2.0	3.0	4.0	5.0
HANDSET FLOW	N/A	N/A	9	9	9	9	9
OVERHEAD FLOW	N/A	N/A	9.1	10.1	10.2	11	11.3

Chrome



1604044



\$" " +) \$%



Please Note: Flow rate will be dictated by installation configurations.
 Please ensure to check the appropriate flow restrictor information if applicable.
 *Please refer to website for full warranty details.

FREEPHONE: 0800 195 1602 | FAX ORDERS: 08444 068 690 | EMAIL: SALES@UK.METHVEN.COM

methven.com

THE INFORMATION ON THIS SPECIFICATION DOCUMENT WAS CORRECT AT THE DATE OF ISSUE. SOME VARIATION MAY OCCUR DUE TO THE MANUFACTURING TOLERANCES AND SITE SPECIFIC CONDITIONS.