

BRISTAN

TAPS & SHOWERS

Installation Instructions & User Guide

Please leave these instructions with the end user

Product Codes: ZI SHXSMCTFF C (D8)

Specifications

Working Pressures

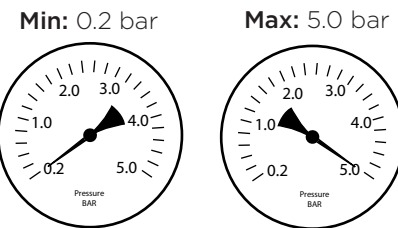

Maximum Static Pressure: 10.0 bar

Inlet Water Temperature

Cold Water Supply

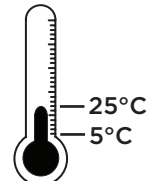

Min: 5°C Max: 25°C
Factory pre-set 38°C

Hot Water Supply

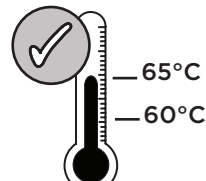

60-65°C Recommended
IMPORTANT
The inlet hot water must be at least 10°C above the required blend temperature.

Inlet Dimensions

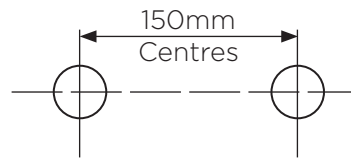

Inlet Connections

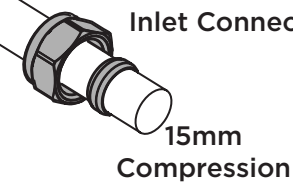

Tools You'll need

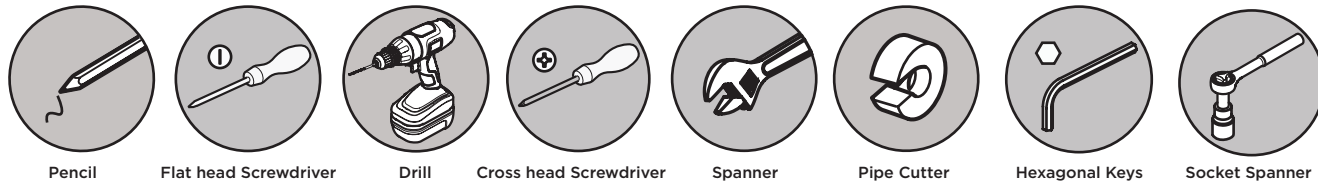

Prior to Installation

All products manufactured and supplied by Bristan are safe to use provided that they are installed, operated and receive regular maintenance in accordance with these instructions.

This product needs to be installed in accordance with, and meet the requirements of the Water Supply (Water Fittings) Regulations 1999 and current by-laws. For full Installation Requirements & Notes (IRN) please visit wras.co.uk/directory.

Isolation valves must be fitted to the inlet water supplies to ensure ease of future maintenance.

Before installing this product the water supply must be thoroughly flushed in order to remove any swarf, solder etc.

This product must not be modified in any way as this will invalidate the guarantee.

Full access must be made available for future maintenance/servicing purposes.

Before drilling into walls, check that there are no hidden electrical wires, cables or water supply pipes. This can be checked with the aid of an electronic detector.

If power tools are used do not forget to:
- Wear eye protection
- Unplug equipment after use

If in doubt, contact a registered plumber or your Local Water Authority or the Secretary of the Institute of Plumbing, address as follows:-

The Institute of Plumbing,
64 Station Lane,
Hornchurch,
Essex,
RM12 6NB, Tel: 01708 472791

Pack Contents

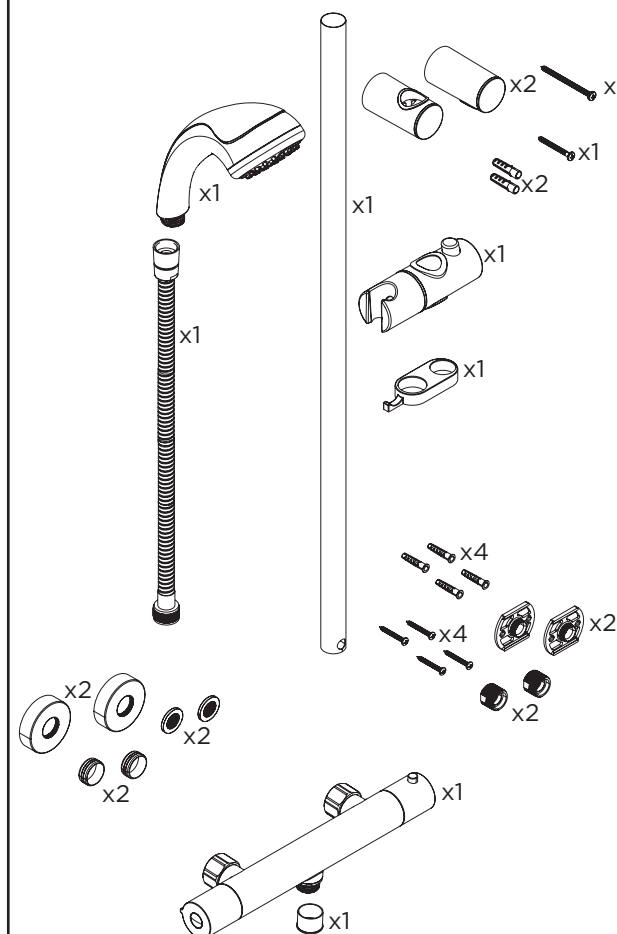

Installation

1

150mm Centres

21mm

REMEMBER
Hot on the left, cold on the right.

Identify the required position of the valve and prepare the water supply pipes. Supply pipes should be 150mm apart.

Using the backplate supplied with the wallmount, mark and drill holes.

2

Secure the rubber backplate and backplate into place.

Secure the screws into the wall.

3

Secure the wall bridges onto the backplate ensuring the olive is positioned over the pipework correctly.

INFORMATION
Pipework must not protrude past the olive by more than 5mm.

4

Screw shrouds to the wall bridges.

5

Insert the filter washers and secure the shower to the wall mount.

REMEMBER
To service your product!

Operation

Temperature Stop

Cold

Hot

Off

On

Temperature Setting

1

Turn the shower on, letting the temperature stabilise.

2

Remove the cap, screw and temperature handle.

3

Turn cartridge spindle clockwise to decrease the temperature. Turn cartridge spindle anti-clockwise to increase the temperature.

4

Reverse steps 1-2 to reinstall the valve, cartridge and handles.

Maintenance - Cartridge Cleaning

1

Remove temperature and flow handle.

2

Unscrew the flow valve.

3

Remove adaptor, nut and cartridge.

4

Remove O-rings and soak all components in de-scaler and wash off in clean water. Examine all seals and replace if needed. Use WRAS approved silicon based grease on all seals.

5

Replace cartridge and turn spindle anti-clockwise to maximum temperature.

6

Replace nut and adaptor, ensure the raised side is facing towards the back of the valve.

7

Turn cartridge spindle clockwise to decrease the temperature. Turn cartridge spindle anti-clockwise to increase the temperature.

8

Slide handle onto adaptor and turn clockwise until you meet resistance.

9

Reverse steps 1-2 to reinstall the valve and secure handles.

Servicing Intervals

To reduce the build up of limescale and to ensure this shower works to its maximum performance we recommend this shower is serviced every 6-12 months depending on the hardness of your water.

Spare Parts

To replace any spare parts for your shower why not scan the below QR Code and search for your product.



REMEMBER
To service your product!

Riser Installation

1

Assemble the riser, attaching the hose retainer, soap dish, slider and both the top and bottom brackets.

2

Use the assembled riser to mark the desired position for the riser on the wall.

3

Drill the marked holes.

4

Slide top bracket onto riser and secure to wall.

5

Insert riser rail into lower bracket, securing to the wall.

6

Slide hose through hose retainer before attaching the handset to the shower.

Troubleshooting

Symptom	Cause	Remedy
No flow or low flow rate	Partially closed isolation valve.	Open isolation valve.
	Instantaneous water heater cycles on and off as flow rate or pressure is too low.	Increase water flow rate or pressure through system.
	Head of water is below the minimum distance required.	2 meters minimum required.
	Hot or cold water being drawn off elsewhere causing pressure changes or instantaneous boiler temperature changes.	Do not use other water outlets when using the taps.
	Airlock or partial blockage in the supply pipework.	Flush through pipework to ensure removal of debris and any airlocks.
Water dripping from shower	This is normal for a short time after using the shower.	This is caused by residual water tension, the build up of water in the shower.
	If water continues to drip, possibly due to the cartridge	Remove cartridge and clean, refer to 'Maintenance' section before starting any maintenance.
Shower does not turn on	Closed isolation valve.	Open isolation valve.
	Mains water supply turned off.	Turn on mains water supply.

At Bristan, we want to make things as easy as possible for our customers. That's why we offer solid guarantees on all our products, effective from the date of purchase, to give you peace of mind.

To start your free guarantee simply scan the QR code and register your product. Alternatively visit www.bristan.com/register.

For any other queries, please call our Customer Service on 0330 026 6273 where our expert team of advisors will be able to offer you any help and advice.

For full guarantee terms and conditions visit www.bristan.com/guarantees.



We Know & We Care